

Chapter 2 - Basic Laws

- This chapter will introduce Ohm's law: a central concept in electric circuits.
- Resistors will be discussed in more detail.
- Circuit topology and the voltage and current laws will be introduced.
- Finally, meters for measuring voltage, current, and resistivity will be presented.

Ch 2, p1

2.1 Introduction

When electrons/charged particles move through a material, some of them will collide with other, heavier particles within the material with the result that some of their kinetic energy is transformed into increased energy/vibration of the heavier particles. The increased energy/vibration is then transformed into thermal energy as indicated by an increase in the temperature of the material.



The property by which a conducting material drains the energy out of an electric current is called *electrical resistance* (or, simply, *resistance*), and even very good conductors demonstrate some degree of electrical resistance. Resistance represents, therefore, a measure of how hard it is to push electric charges (current) through a material.

Electrical circuits are often analogized to simple water/piping systems. In this analogy, the circuit's voltage is similar to water pressure in the water/pipe system, the electric current is similar to the flow of water in the system, and a waterwheel or turbine that transforms the kinetic energy of the water into another form of energy is similar to the load in an electric circuit.

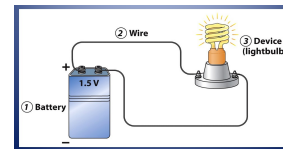

If the plumbing analogy is carried forward, resistance is somewhat analogous to the diameter of the pipe through which the water is flowing since it's easier to push a given amount of water through a pipe with a larger diameter than it is through a pipe with a smaller diameter.

Ch 2, p2

2.2 Ohm's Law

- **Resistivity** (ρ) characterizes the electrical properties of materials.
- Materials that are good conductors have low resistivity. Materials that are poor conductors (and thus good insulators) have high resistivity.
- The resistivity of a metal decreases with increasing temperature.
- A wire made of a material of resistivity ρ , with length L , and cross section area A has resistance

$$R = \frac{\rho L}{A}$$

Resistance of a wire in terms of resistivity and dimensions

- Resistance is a property of a **specific** wire, since it depends on the conductor's length, diameter, and material.

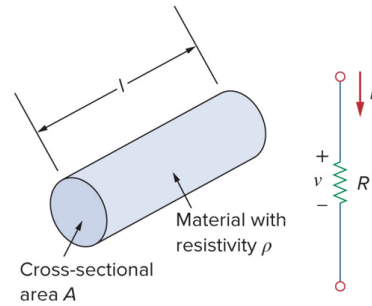

Ch 2, p3

Resistivities of common materials.

Material	Resistivity ($\Omega \cdot m$)	Usage
Silver	1.64×10^{-8}	Conductor
Copper	1.72×10^{-8}	Conductor
Aluminum	2.8×10^{-8}	Conductor
Gold	2.45×10^{-8}	Conductor
Carbon	4×10^{-5}	Semiconductor
Germanium	47×10^{-2}	Semiconductor
Silicon	6.4×10^2	Semiconductor
Paper	10^{10}	Insulator
Mica	5×10^{11}	Insulator
Glass	10^{12}	Insulator
Teflon	3×10^{12}	Insulator

It is important to distinguish between resistivity and resistance.

- resistivity is a property of the material, not any particular piece of it. All copper wires (at the same temperature) have the same resistivity.
- resistance characterizes a specific piece of the conductor that has a specific geometry. A short, thick copper wire has a smaller resistance than a long, thin copper wire.

The relationship between resistivity and resistance is analogous to that between density and mass.

Most electrical conductors are in the form of wires, and wire size is usually noted by the AWG (American Wire Gauge) number where the smaller the number the larger the wire diameter.

Amperage	Copper Wire Size	Aluminum Wire Size
15	14 (1.628 mm)	12
20	12 (2.053 mm)	10
30	10 (2.588 mm)	8
40	10	8
60	10	8
100	8	6

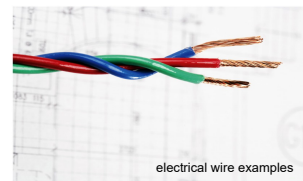

Ch 2, p4

Ch 2 - Basic Laws.notebook

There is a relationship between the resistance in a wire, the current that flows in the wire, and the potential difference between ends of the wire. This relationship can be expressed by simple statement and equation known as *Ohm's Law*.

Ohm's Law can be stated as: **The current in an electric circuit is directly proportional to the voltage and inversely proportional to the resistance.**

The higher the potential difference (voltage) (the electrical "pressure") the higher the current.
The higher the resistance to flow, the lower the current.

As an equation, Ohm's Law can be written: $i = \frac{v}{R}$

where: i represents the current (measured in amps)
 v represents the voltage (measured in volts)
 R is the electrical resistance (measured in ohms).

The SI unit of resistance is the ohm, which is defined as

$$1 \text{ ohm} = 1\Omega = 1 \text{ V/A}$$

Similar to the treatment of Newton's second law, Ohm's Law is more often seen in a slightly different form: $v = iR$

NOTE: Ohm's law requires conforming to the passive sign convention.

PhET Simulation

Ch 2, p5

Since the value of R can range from zero (or almost zero) to infinity (or very, very high), there are two extreme cases of R :

- A connection with almost zero resistance is called a *short circuit*.
- Ideally, any current may flow through the short.
 - In practice this is a connecting wire.
- A connection with infinite resistance is called an *open circuit*.
- Here, no matter the voltage, no current flows.

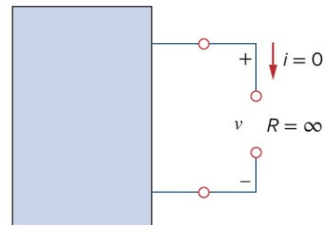
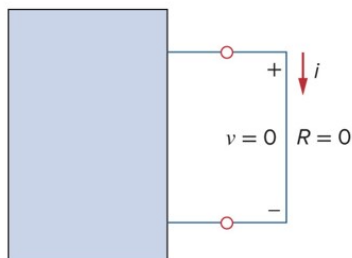

Ch 2, p6

Ch 2 - Basic Laws.notebook

- **Ohm's Law** describes the relationship between the potential difference across a conductor and the current passing through it:

$$I = \frac{\Delta V}{R}$$

Ohm's law for a conductor of resistance R

- Ohm's law is not a law of nature; it is limited to those materials whose resistance R remains constant during use.
- Materials to which Ohm's law applies are called **ohmic**.
- The current through an ohmic material is directly proportional to the potential difference.
- Other material and devices are **nonohmic**, meaning the current through the device is **not** directly proportional to the potential difference.
- Resistors that obey Ohm's law are also known as *linear resistors* while those that do not are known as *nonlinear resistors*.

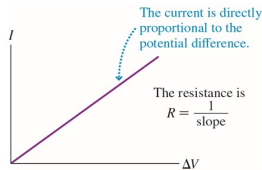

A resistor may be either fixed or variable.

As the name implies, the resistance of a fixed resistor remains constant (or nearly constant). The symbol for a fixed resistor is:

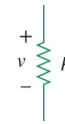

Variable resistors have adjustable resistance. Such resistors may also be known as *potentiometers* or *pots* for short. The symbols for variable resistors and a pot are:



Ch 2, p7

Resistance represents how hard it is to push electric charges (current) through an element of a circuit. Conductance, on the other hand, is a measure of how well an element conducts electric current.

Conductance is the ability of an element to conduct electric current. It is the reciprocal of R , is denoted by G , and is measured in mhos (\mathcal{U}) or siemens (S).

$$G = 1/R = i/v \quad 1 \text{ S} = 1 \mathcal{U} = 1 \text{ A/V}$$

The same resistance can be expressed in ohms or siemens: 10Ω is the same as 0.1 S .

Combining the equation for conductance with the equation for power ($p = iv$), the power dissipated by a resistor can be expressed as:

$$p = iv = i^2 R = v^2 / R \quad p = iv = v^2 G = i^2 / G$$

Two things to note:

1. the power dissipated in a resistor is a nonlinear function of either current or voltage.
2. the power dissipated in a resistor is always positive since R and G are always positive. Thus, a resistor always absorbs power from a circuit, confirming that it is a passive element and incapable of generating energy.

Ch 2, p8

Ch 2 - Basic Laws.notebook

2.3 Nodes, Branches and Loops

Some introductory vocabulary.

A **network** is an interconnection of elements or devices.

A **circuit** is a network providing one or more closed paths.

The study of networks involves the placement of elements in the network and the geometric configuration of the network. The elements of particular interest in this course include branches, nodes and loops.

A **branch** represents a single element such as a voltage source or resistor (i.e., any two-terminal element).

A **node** is a point of connection between two or more branches.

A node is usually indicated by a dot in a circuit diagram. If a short circuit (a connecting wire) connects two or more nodes, those nodes constitute a single node.

A **loop** is any closed path in a circuit.

A loop is a closed path starting at a node, passing through a set of nodes, and returning to the starting point without passing through any node more than once. A loop is said to be independent if it contains at least one branch that is not part of any other independent loop.

Ch 2, p10

This circuit contains how many

branches?

nodes?

loops?

independent loops?

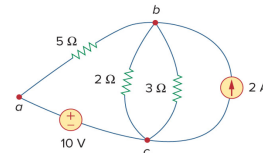
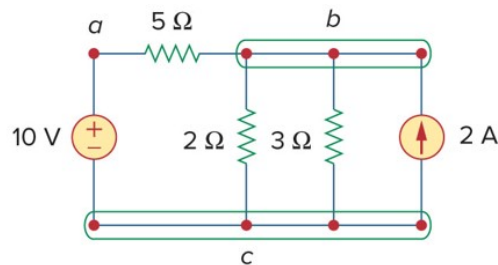

A network with b branches, n nodes, and l independent loops will satisfy the fundamental theorem of network topography: $b = l + n - 1$

Ch 2, p11

Ch 2 - Basic Laws.notebook

Two or more elements are said to be in **series** if they exclusively share a single node and, consequently, carry the same current.

Two or more elements are said to be in **parallel** if they are connected to the same two nodes and, consequently, have the same voltage across them.

In this circuit, which elements are

in series?

in parallel?

neither in series or in parallel?

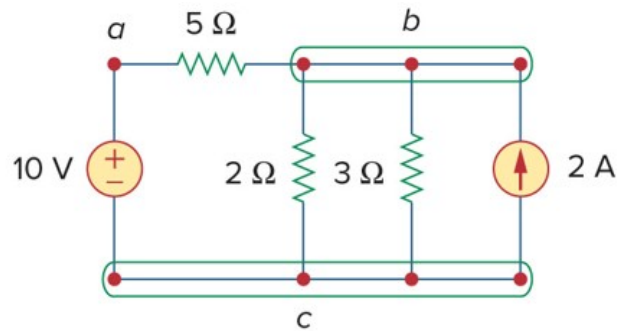

Ch 2, p12

Example and Practice Problems

E2.4. How many branches and nodes are there in the circuit shown below? Which elements are in series and which are in parallel?

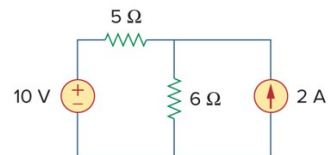

P2.4 How many branches and nodes are there in the circuit shown below? Which elements are in series and which are in parallel?

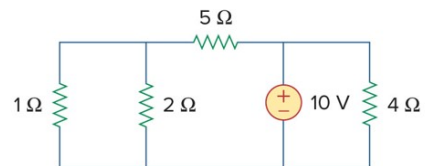

Ch 2, p13

2.4 Kirchoff's Laws

As useful as Ohm's law might be, complete analysis of circuits requires the use of two additional tools.

KCL

- Kirchoff's current law is based on conservation of charge
- It states that the algebraic sum of currents entering a node (or a closed boundary) is zero.
- It can be expressed as:

$$\sum_{n=1}^N i_n = 0$$

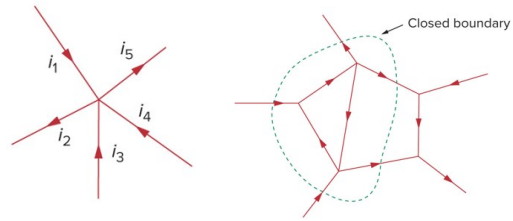

The sum of the currents entering a node is equal to the sum of the currents leaving the node.

Ch 2, p14

KVL

- Kirchoff's voltage law is based on conservation of energy
- It states that the algebraic sum of voltages around a closed path (or loop) is zero.
- It can be expressed as:

$$\sum_{m=1}^M v_m = 0$$

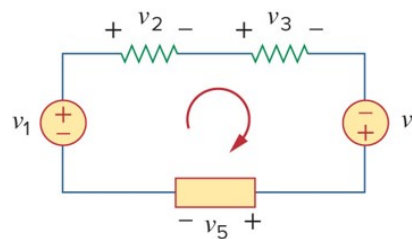

The sum of voltage drops = the sum of voltage rises.

The sum of the drops and rises around a circuit has to equal 0

Ch 2, p15

Ch 2 - Basic Laws.notebook

Example and Practice Problems

E2.5 Find the values for v_1 and v_2 in this circuit.

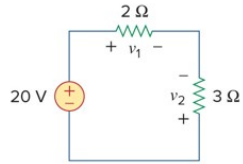

P2.5 Find the values for v_1 and v_2 in this circuit.

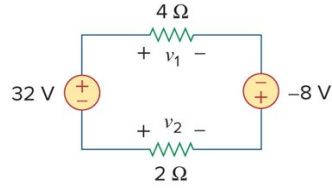

E2.6 Find v_o and i in this circuit.

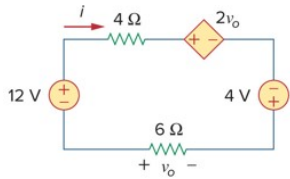

P2.6 Find v_x and v_o in this circuit.

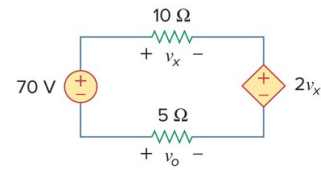

Ch 2, p16

Example and Practice Problems (Cont.)

E2.7 Find i_o and v_o in this circuit.

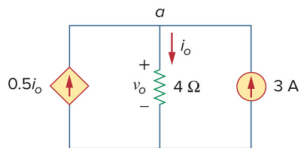

P2.7 Find i_o and v_o in this circuit.

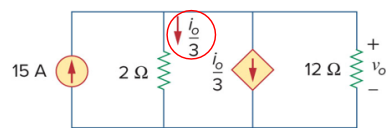

E2.8 Find the currents and voltages in this circuit.

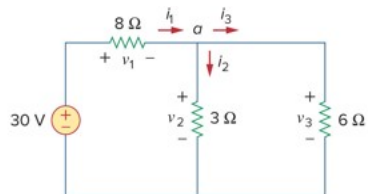

P2.8 Find the currents and voltages in this circuit.

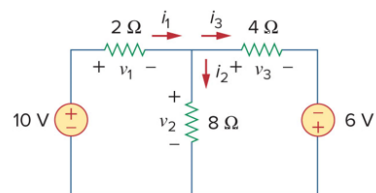

Ch 2, p17

2.5 Series Resistors and Voltage Division

- Two resistors are considered in series if the same current passes through them

- Applying Ohm's law to both resistors

$$v_1 = iR_1 \quad v_2 = iR_2$$

- If we apply KVL to the loop we have:

$$-v + v_1 + v_2 = 0$$

- Combining the two equations:

$$v = v_1 + v_2 = i(R_1 + R_2)$$

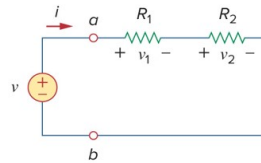

- From this we can see there is an equivalent resistance of the two resistors:

$$R_{eq} = R_1 + R_2$$

- For N resistors in series:

$$R_{eq} = \sum_{n=1}^N R_n \quad R_{EQ} = R_1 + R_2 + R_3 + \dots$$

Ch 2, p18

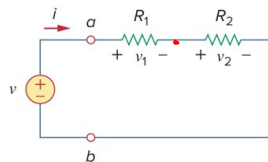

The equivalent resistance of any number of resistors connected in series is the sum of the individual resistors.

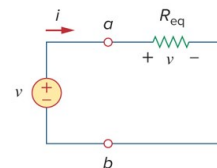

- Two resistors are considered in series if the same current passes through them

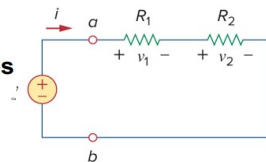

- The current through all the resistors is the same, so using Ohm's law:

$$v_1 = \frac{R_1}{R_1 + R_2} v \quad v_2 = \frac{R_2}{R_1 + R_2} v$$

- This is the principle of voltage division

Ch 2, p19

2.6 Parallel Resistors and Current Division

- When resistors are in parallel, the voltage drop across them is the same

$$v = i_1 R_1 = i_2 R_2$$

- By KCL, the current at node a is

$$i = i_1 + i_2$$

- The equivalent resistance is:

$$R_{eq} = \frac{R_1 R_2}{R_1 + R_2}$$

- Given the current entering the node, the voltage drop across the equivalent resistance will be the same as that for the individual resistors

$$v = i R_{eq} = \frac{i R_1 R_2}{R_1 + R_2}$$

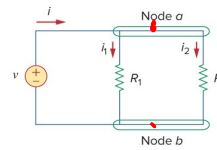

- This can be used in combination with Ohm's law to get the current through each resistor:

$$i_1 = \frac{i R_2}{R_1 + R_2} \quad i_2 = \frac{i R_1}{R_1 + R_2}$$

- For N resistors in parallel:

$$R_{EQ} = \frac{1}{\left[\frac{1}{R_1} + \frac{1}{R_2} + \frac{1}{R_3} + \dots \right]}$$

- For the special case of two resistors in parallel:

$$R_{eq} = \frac{R_1 R_2}{R_1 + R_2}$$

Ch 2, p20

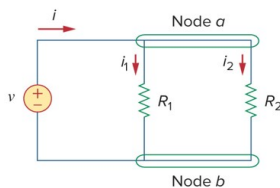

The reciprocal of the equivalent resistance of any number of resistors connected in parallel is the sum of the reciprocals of the individual resistors.

Note: R_{eq} has to be smaller than the resistance of any of the resistors in the parallel combination.

Since conductance is the reciprocal of resistance, it is often more convenient to use conductance rather than resistance when dealing with resistors in parallel.

The equivalent conductance for N resistors in parallel is the sum of their individual conductances:

$$G_{eq} = G_1 + G_2 + G_3 + \dots + G_N$$

The equivalent conductance for N resistors in series is ??????

Ch 2, p21

Ch 2 - Basic Laws.notebook

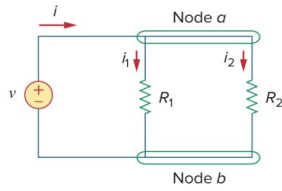

- Given the current entering the node, the voltage drop across the equivalent resistance will be the same as that for the individual resistors

$$v = iR_{eq} = \frac{iR_1R_2}{R_1 + R_2}$$

- This can be used in combination with Ohm's law to get the current through each resistor:

$$i_1 = \frac{iR_2}{R_1 + R_2} \quad i_2 = \frac{iR_1}{R_1 + R_2}$$

- This is the principle of current division.

The total current is shared by the resistors in inverse proportion to their resistances, i.e., the larger current will flow through the smaller resistance and vice versa.

Think back to plumbing as an analogy --- if a 4" pipe goes into a tee with a 1" leaving one side of the tee and a 3" pipe leaving the other, which of the exiting pipes will have the larger flow?

Ch 2, p22

What is the equivalent resistance of this group of resistors?

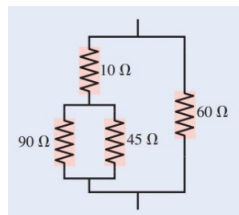

Ch 2, p23

Ch 2 - Basic Laws.notebook

Example and Practice Problems

E2.9 Find R_{eq} for this circuit.

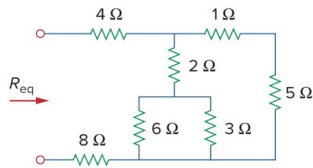

E2.10 Find R_{ab} for this circuit.

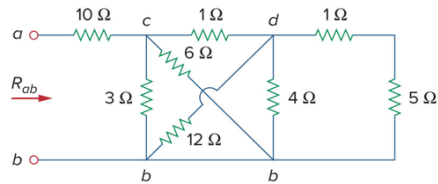

P2.9 Find R_{eq} for this circuit.

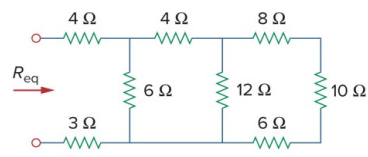

P2.10 Find R_{ab} for this circuit.

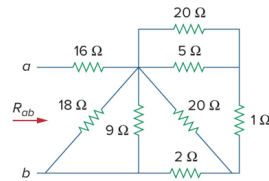

Ch 2, p24

Example and Practice Problems (Cont.)

E2.12 Find i_o and v_o in this circuit as well as the power dissipated by the 3 ohm resistor.

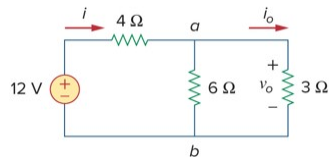

E2.13 Find v_o , the power supplied by the current source, and the power absorbed by each resistor in this circuit.

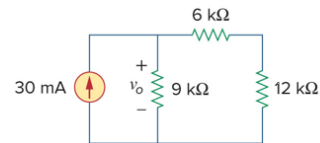

Ch 2, p25

2.7 Wye-Delta Transformations

- There are cases where resistors are neither parallel nor series
- Consider the bridge circuit shown here
- This circuit can be simplified to a three-terminal equivalent
- Two topologies can be interchanged:
 - Wye (Y) or tee (T) networks
 - Delta (Δ) or pi (Π) networks

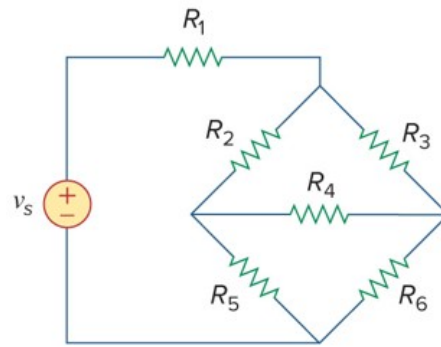

Ch 2, p26

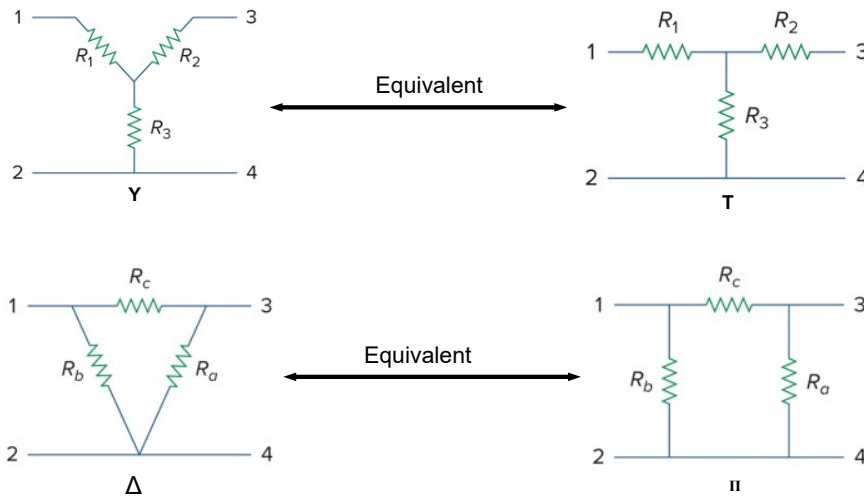

Ch 2, p27

- The superimposed wye and delta circuits shown here will be used for reference
- The delta network consists of the outer resistors, labeled a,b, and c
- The wye network consists of the inside resistors, labeled 1,2, and 3

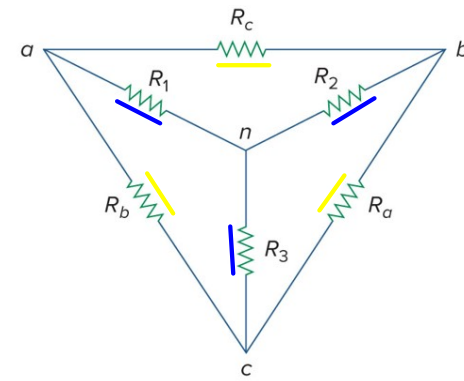

Ch 2, p28

Delta to Wye

- The conversion formula for a delta to wye transformation are:

$$R_1 = \frac{R_b R_c}{R_a + R_b + R_c}$$

$$R_2 = \frac{R_c R_a}{R_a + R_b + R_c}$$

$$R_3 = \frac{R_a R_b}{R_a + R_b + R_c}$$

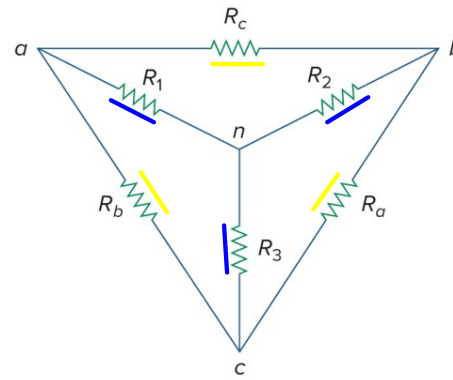

Each resistor in the Y network is the product of the resistors in the two adjacent delta branches, divided by the sum of the three delta resistors.

Ch 2, p29

Wye to Delta

- The conversion formula for a wye to delta transformation are:

$$R_a = \frac{R_1 R_2 + R_2 R_3 + R_3 R_1}{R_1}$$

$$R_b = \frac{R_1 R_2 + R_2 R_3 + R_3 R_1}{R_2}$$

$$R_c = \frac{R_1 R_2 + R_2 R_3 + R_3 R_1}{R_3}$$

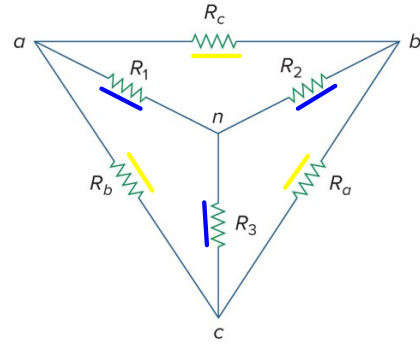

Each resistor in the delta network is the sum of all possible products of the Y resistors taken two at a time, divided by the opposite Y resistor.

Ch 2, p30

Example Problem

- E2.15 Find the equivalent resistance R_{ab} for the circuit shown below and use it to find current i .

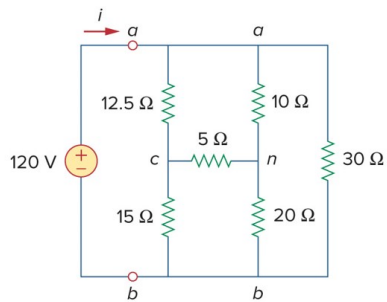

Ch 2, p31